

BLAUPUNKT



VELOCITY POWER
CLASS D AMPLIFIER with DSP
MP 68A



Enjoy it.

Operating and Installation Instructions

CAUTIONS

This device has been manufactured according to established safety guidelines. However, dangers may still occur if the safety notes in this manual is not observed. This manual is intended to familiarize the user with the device's important functions. Read this carefully, prior to using the car radio. Keep this manual in an easily accessible location. In addition, do observe the instructions of other devices used in conjunction with this device.

Installation Safety Notes

Always observe the following safety notes:

- Device must be used in a way that compliments safety of the user when driving the vehicle. It is recommended for the user to install at an appropriate location when operating the device. While driving, user is not recommended to use applications that can be prone to distraction.
- Before installation, disconnect the negative terminal of the battery. Refer to the safety vehicle manufacturer's user manual.
- Ensure positions of the holes are nowhere near the vehicle component to avoid any damage during drilling.
- Ensure cross section of the cables is no less than 2.5mm if the positive and the negative cables are too long. incorrect installation may result in malfunction of the device or the car sound system.
- Select a dry and well-ventilated location to install the device.
- The device must not be installed in overly exposed location.
- The installation location must be suitable for screw holes and stable ground support

General Safety Notes:

Observe the following for protection against injuries:

- User is advised to keep the volume of the car radio to a moderate level for the protection of the ears and to increase the ability to hear any emergency warning signals (e.g. police and ambulance sirens). Do not increase the car radio volume while the car radio is muted as it is not audible. The car radio volume can be too loud when the car radio is unmuted.

Disclaimer

- Blaupunkt is not liable for any loss or damage caused or resulting from unauthorized disassembly or modification to the product.
- In no event shall Blaupunkt be liable for any direct, indirect, punitive, incidental, special consequential damages, to property or life, improper storage, whatsoever arising out of or connected with the use or misuse of our products.
- USA & CANADA : Products not intended for sales in the United States and Canada. If purchased in the U.S. or Canada, this product is purchased as-is. No warranty, expressed or implied is provided in the U.S. and Canada.

Voltage Supply

- +12V : Positive connection terminal for car 12V power supply.
- GND : Power supply negative connection terminal.
- Firmly and carefully connect the ground lead to a bare metal point on the vehicle chassis.
- Operation temperature : 0° - 70°C

Compatible PC OS

- With or higher than PC OS Windows XP, 1.5GHz, 1GB RAM processor speed, 1024x600 resolution

Scope of Delivery

- DSP Signal Interface Processor (163 x 378 x 47mm)
- 5.0m USB cable
- Control High Level Input
- 4 of 4x15mm / 8 of 3x6mm self-tapping, screws
- DSP 1.0 SW CD or visit www.blaupunkt.com/ase to download (Windows only)
- Digital Remote Control (DRC) Control Panel (Optional)
- 5.0m DRC AC Link Cable

INPUT FUNCTION

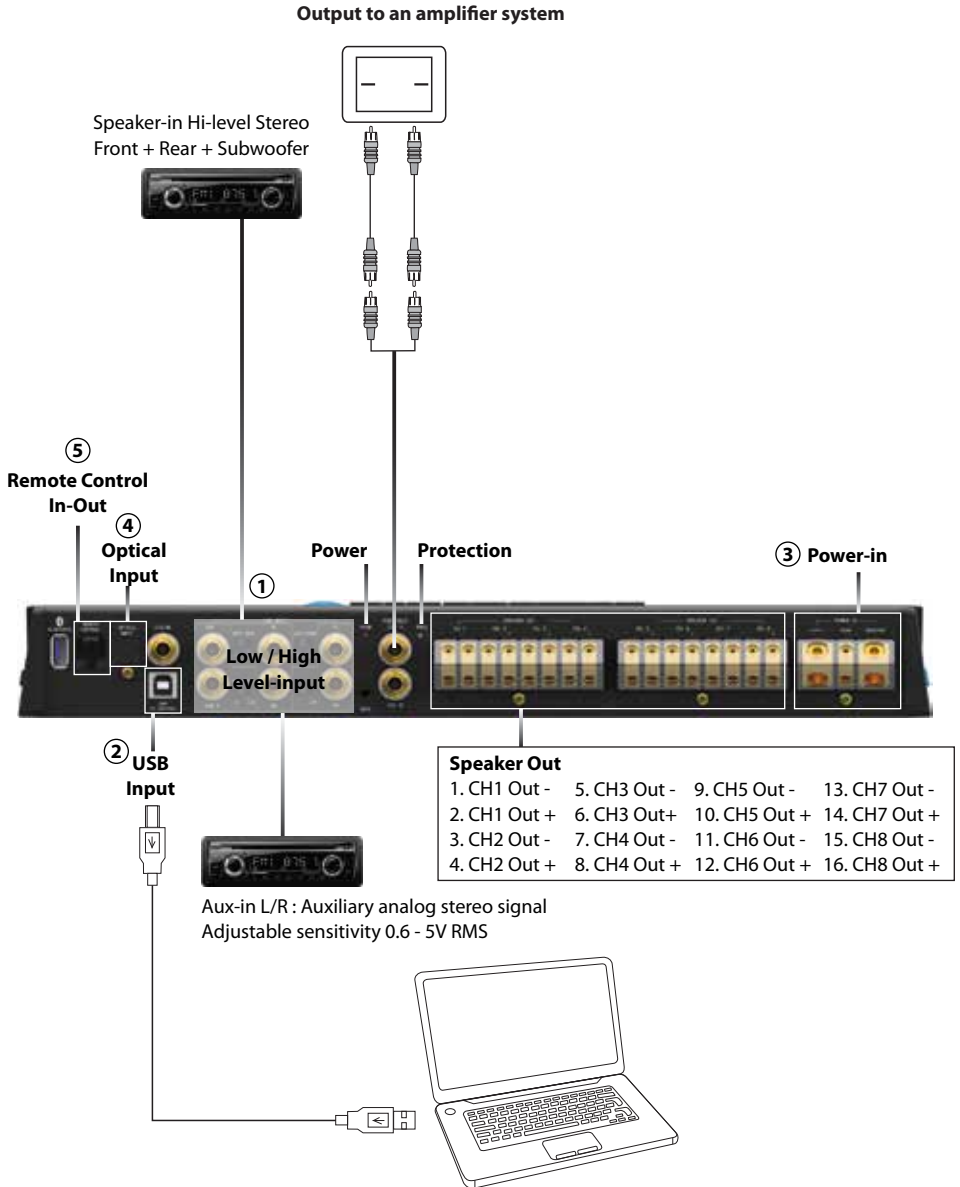

INPUT FUNCTION

INPUT SIGNAL

① Low/High Level-input

Line Inputs : FR-FL-RR-RL, SUB R-SUB L inputs (Speakers)

The DSP comes with 6 High Level Signal inputs to connect amplified signal cables coming from the main Analog source. Input sensitivity is adjustable between 2 - 15V RMS.

Low Level-input

The DSP comes with an auxiliary stereo signal input for external connection. Source input sensitivity is adjustable between 0.3 - 5 VRMS.

Remark

If low-level output (Pre-out) with output signal ≥ 2 VRMS is available, connect it to high-level MASTER input (speakers). Adjust the sensitivity using the Level controls.

② USB INPUT

Connect PC to the processor through the USB (type B) input to adjust its setting with the downloaded DSP software. Visit www.blaupunkt.com/ase to download.

REMOTE CONTROL OUTPUT

③ Power-in

+12V : Positive terminal for 12V vehicle power supply

GND : Power supply negative terminal (GND)

Warning : Ensure the polarity connection is as indicated on the terminals. Misconnection may damage the DSP .

After completing the wire connections, wait for at least 10-sec before turning on the DSP.

④ Optical Input

Warning : The DSP must be turned on before turning on any amplifiers. Car radio's REM-out must be connected to DSP's REM-in whenever Optical-in is connected with car radio's Optical-out.

⑤ Remote Control In-Out

REM-in : Input to turn on the processor remotely along with the audio signal remote out.

INSTALLATION & WIRING DIAGRAM

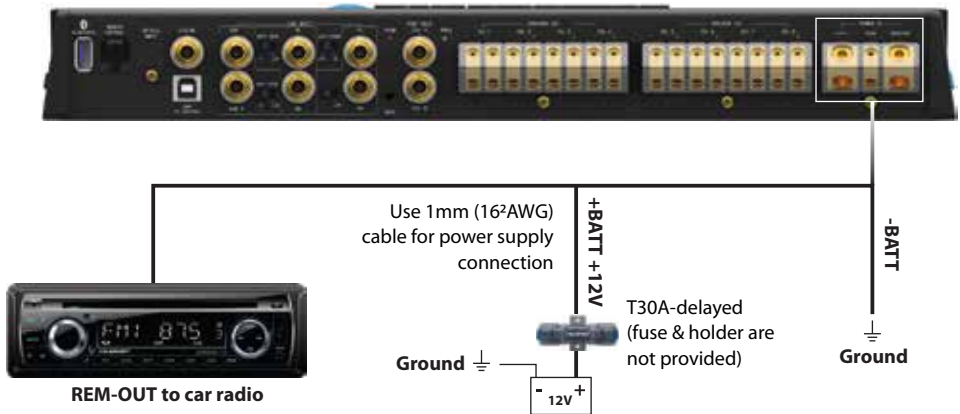

Remark : The device is protected by its built-in fuse-resistor

INSTALL SOFTWARE

1. Insert Software CD into the PC and double-click on *Blaupunkt DSP Setup EN* to begin installing software. (Software is also available at www.blaupunkt.com/ase)

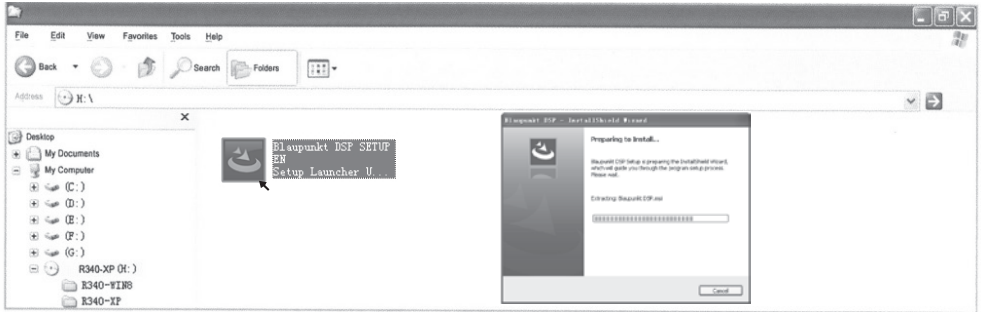

2. Click NEXT



3. Click CHANGE to change file saving location if prefer, then click NEXT

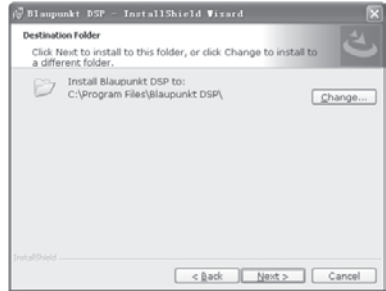

4. Click INSTALL and wait

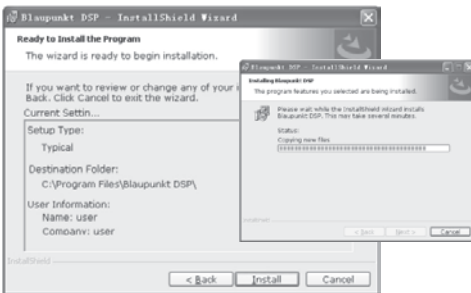

5. Click FINISH

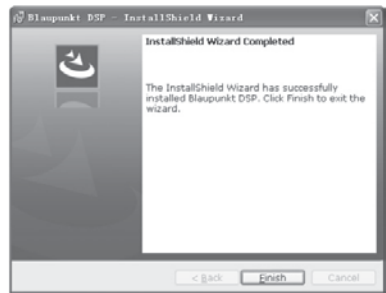

SOFTWARE OPERATION

Double-click on Blaupunkt DSP software to began using



Blaupunkt DSP 1.0

Car entertainment enthusiast / experts may now begin to tone signal details. Enhance the sound effect according to your very own preference for optimum music enjoyment with the DSP software

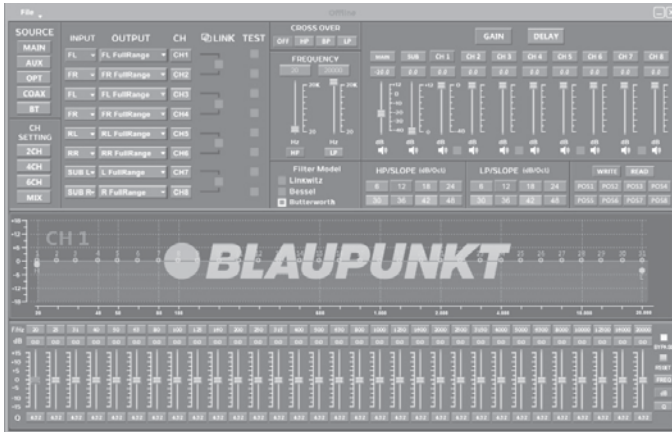

1. FILE

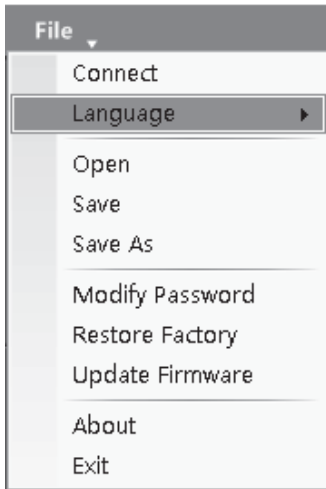

Click **File** for **Main Menu**

1. Connect (connect to the DSP)
2. Language (choose the preferred language)
3. Open (To load preset file in PC folder)
4. Save
5. Save as
6. Change Password
7. Reset (All setting will reset to default setting)
8. Update Firmware
9. About
10. Exit

SOFTWARE OPERATION

2. INPUT MODE

To select different input devices



3. CHANNEL SETTING

i. Optional Fullrange

2-way crossover. 3-way crossover. Clear All



ii. CH Setting (click on the default in put state)



iii. INPUT Channel

Click the drop-down button to adjust channel input

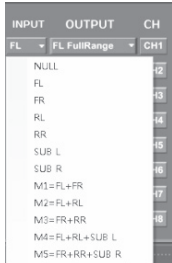

iv. Output Channel

Click the drop-down button to adjust channel input

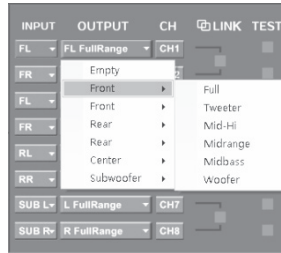

Options on the LINK are for combine setting for Left/ Right CH. Tone each selected channel with Left/Right CH

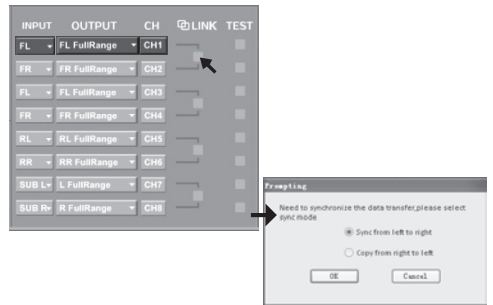

4. CROSSOVER X-TYPE



5. CROSSOVER FREQUENCY

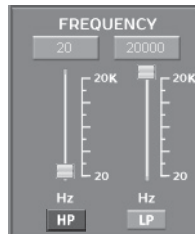

SOFTWARE OPERATION

6. GAIN

0-40dB is optional range for gain control kf every CH

7. DELAY

- i. Auto configuration (base on 1.5 setting)
- ii. Manual configurations in selected CH manually

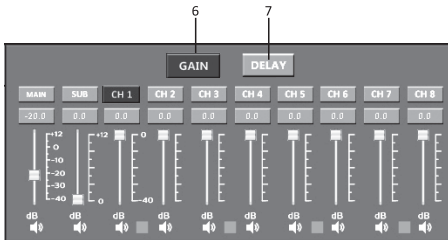

8. LP/SLOPE

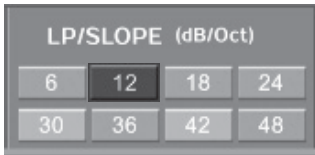

9. HP/SLOPE

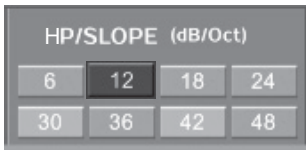

10. FILTER MODEL



11. WRITE

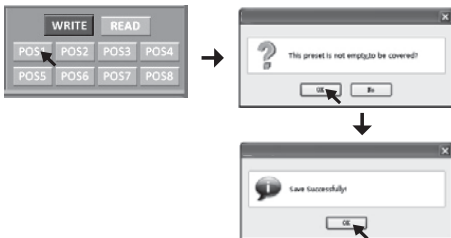

12. READ

i. To read setting from DSP (POS1-POS8)



ii. To delete setting from DSP (POS1-POS8)

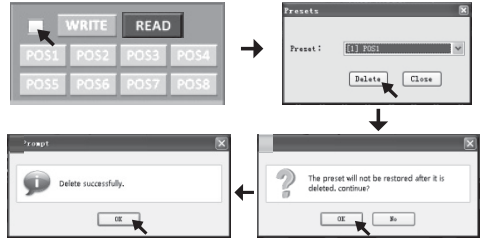

13. X-OVER AND EQ CHARTS

i. Red lines and slopes will change when HP/LP of crossover and EQ are modified.

ii. EQ frequency points can be move left/right. For 20Hz - 20kHz can be any regulation.



14. EQ SETTING

Q value = 1-12



INSTALLATION REFERENCE

CHANNEL STAND ALONE TREBLE MODE

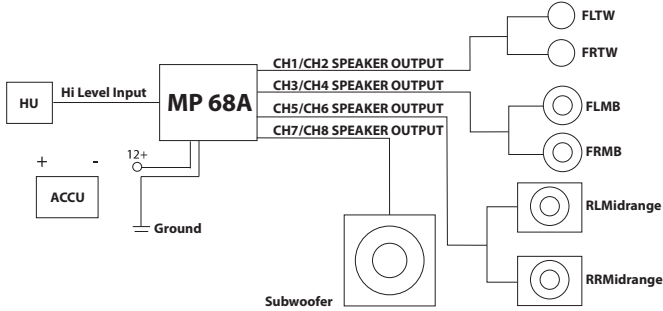

SOURCE	INPUT	OUTPUT	CH
MAIN	FL	FL FullRange	CH1
AUX			
OPT	FR	FR FullRange	CH2
COAX	FL	FL FullRange	CH3
BT	FR	FR FullRange	CH4
CH SETTING			
2CH	RL	RL Tweeter	CH5
4CH	RR	RR Tweeter	CH6
6CH	SUB L	L Subwoofer	CH7
MIX	SUB R	R Subwoofer	CH8

2-WAY CROSSOVER TREBLE MODE

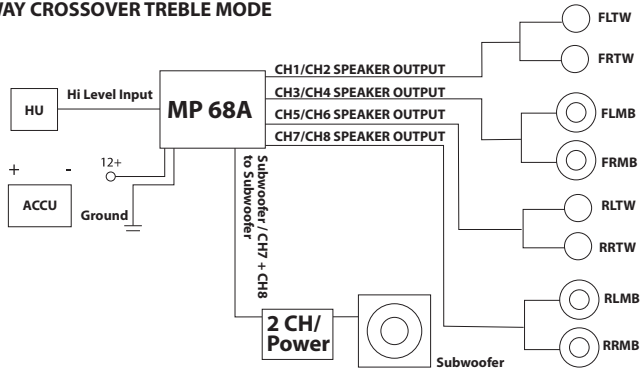

SOURCE	INPUT	OUTPUT	CH
MAIN	FL	FL FullRange	CH1
AUX			
OPT	FR	FR FullRange	CH2
COAX	FL	FL FullRange	CH3
BT	FR	FR FullRange	CH4
CH SETTING			
2CH	RL	RL Tweeter	CH5
4CH	RR	RR Tweeter	CH6
6CH	SUB L	L Subwoofer	CH7
MIX	SUB R	R Subwoofer	CH8

3-WAY CROSSOVER TREBLE MODE

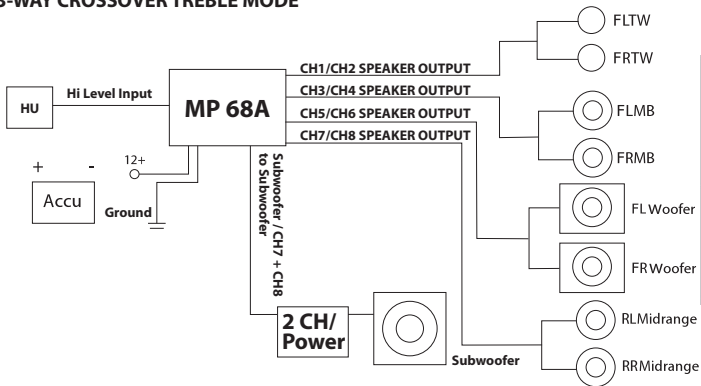

SOURCE	INPUT	OUTPUT	CH
MAIN	FL	FL FullRange	CH1
AUX			
OPT	FR	FR FullRange	CH2
COAX	FL	FL FullRange	CH3
BT	FR	FR FullRange	CH4
CH SETTING			
2CH	RL	RL Tweeter	CH5
4CH	RR	RR Tweeter	CH6
6CH	SUB L	L Subwoofer	CH7
MIX	SUB R	R Subwoofer	CH8

REMOTE CONTROL KEY FUNCTION

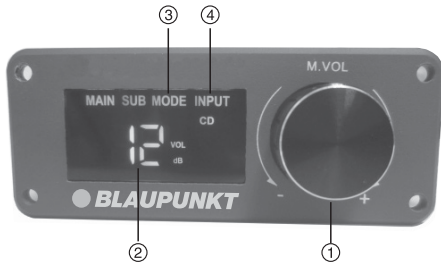

1.
 - a. Adjust Volume
 - b. Press once to MUTE/UNMUTE
 - c. Press and hold to enter MENU mode
2. Volume display
3. DSP mode display window (1-8)
4. Input display status (CD - AUX - SPDIF - BT)

