

4-WAY QUADAXIAL SPEAKERS

BGx 1404 N



BGx 1544 N



BGx 1664 N



BGx 1694 N



Enjoy it.

OPERATING & INSTALLATION INSTRUCTION

BGx 1404 N

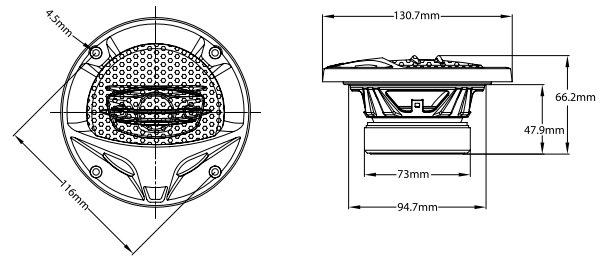
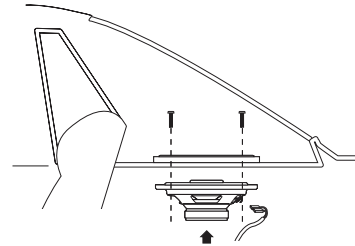

Pair of 4" 4-way quadaxial speakers with PP injected cone including mounting hardware

- Max. Output Power : 60W
- Normal Output Power (RMS) : 20W
- Impedence : 4 ohms
- Frequency Response : 100Hz - 20,000Hz
- Sensitivity : 85dB
- Mounting Depth : 47.9mm
- Diameter Hole : 116mm
- Surround : Rubber

OPERATING & INSTALLATION INSTRUCTION

BGx 1544 N

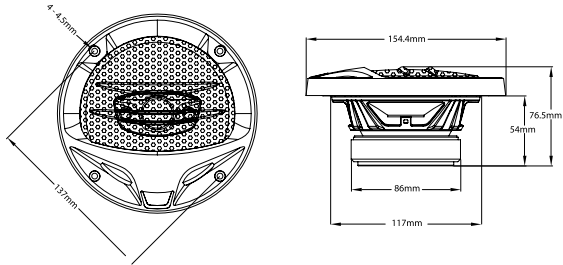
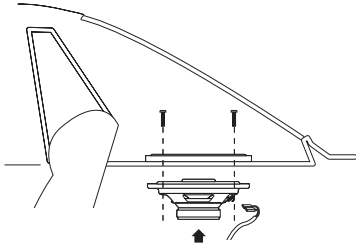

Pair of 5.4" 4-way quadaxial speakers with PP injected cone including mounting hardware

- Max. Output Power : 80W
- Normal Output Power (RMS) : 25W
- Impedance : 4 ohms
- Frequency Response : 80Hz - 20,000Hz
- Sensitivity : 88dB
- Mounting Depth : 54mm
- Diameter Hole : 137mm
- Surround : Rubber

OPERATING & INSTALLATION INSTRUCTION

BGx 1664 N

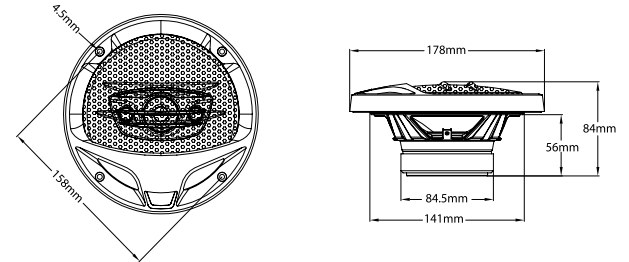
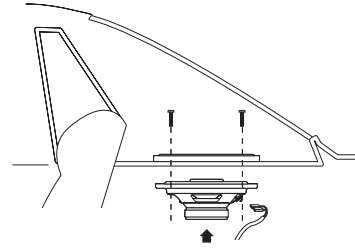

Pair of 6.6" 4-way quadaxial speakers with PP injected cone including mounting hardware

- Max. Output Power : 100W
- Normal Output Power (RMS) : 30W
- Impedance : 4 ohms
- Frequency Response : 65Hz - 20,000Hz
- Sensitivity : 88dB
- Mounting Depth : 56mm
- Diameter Hole : 158mm
- Surround : Rubber

OPERATING & INSTALLATION INSTRUCTION

BGx 1694 N

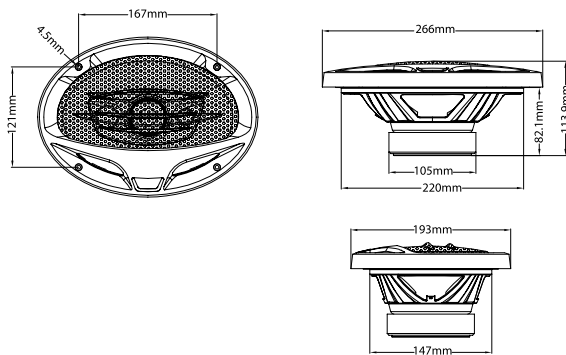
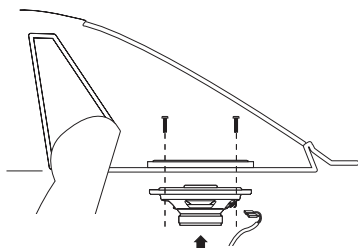

Pair of 6"x9" 4-way quadaxial speakers with PP injected cone including mounting hardware

- Max. Output Power : 120W
- Normal Output Power (RMS) : 40W
- Impedence : 4 ohms
- Frequency Response : 65Hz - 20,000Hz
- Sensitivity : 88dB
- Mounting Depth : 82.1mm
- Diameter Hole : 167 x 121mm
- Surround : Rubber



BGx 1404 N
1 111 17 001 07 01

BGx 1544 N
1 111 17 002 07 01

BGx 1644 N
1 111 17 003 07 01

BGx 1694 N
1 111 17 004 07 01