

BLAUPUNKT



CAR RADIO
HAMBURG 100



Enjoy it.

CAUTIONS

PLACING THE DEVICE IN OPERATION

Caution!

Vehicle screws

Ensure vehicle screws are removed before installation. (See "Installation" instructions).

Road Safety

Always observe the following notes for road safety:

- Car radio must be used in a way that compliments safety of the user when driving the vehicle. It is recommended for the user to at an appropriate location when operating the car radio. While driving, user is not recommended to use applications that can be prone to distraction e.g. streaming to videos, entering destination etc.
- User is recommended to proceed with proposed driving routes only if it does not violate any traffic regulations. Local traffic signs and regulations always prevail over the routes proposed.
- User is advised to keep the volume of the car radio to a moderate level for the protection of the ears and to increase the ability to hear any emergency warning signals (e.g. police and ambulance sirens). Do not increase the car radio volume while the car radio is muted as it is not audible. The car radio volume can be too loud when the car radio is unmuted.
- For abnormalities, please refer to the "Troubleshooting" section. If the problem cannot be resolved, please press the Reset button to recover its factory settings. Otherwise, please contact respective installer/seller directly for help.
- As SD/USB file formats, codecs, bitrate, resolution and other parameters available in the market are not all the same, there is no guarantee that this car radio can play all media file formats.
- Different cars may have different configurations. It is normal that some CAN-Bus functions cannot be enabled because it is not supported by the user's car or this car radio.
- Solvents, cleaning and scouring agents as well as dashboard spray and plastics care products may contain materials which can damage the surface and screen of the car radio. Use only dry or slightly moistened cloth to clean the car radio surface and screen.

General Safety Notes:

Observe the following for protection against injuries:

- This car radio is intended for installation and operation in a vehicle with 12V vehicle system outage, hence the radio unit must be installed in a DIN slot. Observe the output limits of the car radio. Do not dismantle or modify the car radio. Installation and repairs, if necessary, should be performed by a specialist. We are not liable for any loss or damage caused or resulting from unauthorized disassembly or modification to the product.
- This car radio's core components may result to damage when the car is driven on bumpy roads for a prolonged period of time or if it is used to play non-standard or severely damaged discs.
- Please do not operate the car radio under extreme temperature conditions (extremely high temperature or extremely low temperature); make sure that temperature within the car ranges from -20°C to 80°C before you connect the car radio to the power supply

This manual may be updated from time to time without any notice.

Road Safety

In no event shall Blaupunkt be liable for any direct, indirect, punitive, incidental, special consequential damages to property or life and whatsoever arising out of or connected with the use or misuse of our products.

USA & CANADA: This product is not intended for sale in the United States and Canada. If purchased in the U.S. or Canada, this product is purchased on as-is basis. No warranty, whether expressed or implied is provided in the U.S. or Canada.

Scope of Delivery

- 1 Car radio
- 1 Operating & installation instructions
- 1 Remote control (incl. battery)
- 1 Connecting cable chamber A
- 1 Connecting cable chamber B
- 1 Support frame
- 2 Removal key

KEY FUNCTION

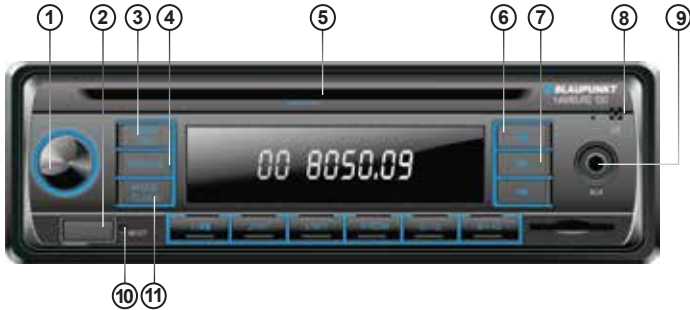

Press any button to turn on the device

① VOLUME/MODE

- Turn knob left or right to increase/decrease volume.
- Radio mode ; Press to select **BAS-TRE-BAL-FAD-EQ-LOUD-LOC-STEREO**, turn knob to adjust.
 - **BAS** : Bass
 - **TRE** : Treble
 - **BAL** : Balance
 - **FAD** : Fader
 - **EQ** (Equalizer) : Flat/Pop/Rock/Classic
 - **LOUD**
 - **LOC** : Turn knob for LOC ON to reduce the receiving sensitivity when searching stations in Local mode, therefore only strong signal stations will be received. LOC OFF will allow device to receive weak signal stations.
 - **STEREO** : Turn knob to switch between Stereo or Mono.

② USB

③ BND/AMS

- Radio mode : Press to change radio band (18FM) or press & hold to preset button 1~6 with auto memory stations.
- USB/SD mode : Press to search file according to NUM/FILE/DIR. Use button 1~6, 7 (MODE/CLOCK), 8 (◀◀), 9 (▶▶), to key in the number and wait for the device to load the song.

④ Power/MUTE

- Press to mute/unmute sound output.
- Press & hold to power on/off.

⑤ CD Slot

Insert disc with the printed side up.

⑥ EJECT

⑦ I<<

- Radio mode : Press to auto seek down or press & hold for manual seek down.
- USB/SD mode : Press to return to previous song or press & hold to Fast Rewind.
- NUM/FILE/DIR song selection : V/W/X/8

⑧ IR SENSOR

⑨ AUX-IN

Connect the device and the media storage (eg: Mobile phone, MP3 player) with a 3.5mm jack.

⑩ RESET

Reset the device to default setting.

⑪ MOD/CLK

- Press to switch between media **RADIO-PHONE-DISC-USB-CARD-AUXIN**
- Press & hold for clock setting (Use ⑦ or ⑩ to adjust)
- NUM/FILE/DIR song selection : S/T/U/7

⑫ 1/>II

- Radio mode : Press & hold to preset station
- USB/SD mode : Pause/Play
- NUM/FILE/DIR song selection : A/B/C/1

⑬ 2/INT

- Radio mode : Press & hold to preset station
- USB/SD mode : Introduction, play the first 10 seconds of each tracks
- NUM/FILE/DIR song selection : D/E/F/2

⑭ 3/RPT

- Radio mode : Press & hold to preset station
- USB/SD mode : Repeat 1 / Repeat All
- NUM/FILE/DIR song selection : G/H/I/3

KEY FUNCTION



Press any button to turn on the device



Insert SDHC this way

⑮ 4/RDM

- Radio mode : Press & hold to preset station
- USB/SD mode : Random On/Off (Shuffle Play)
- NUM/FILE/DIR song selection : J/K/L/4

⑯ 5/-10

- Radio mode : Press & hold to preset station
- USB/SD mode : Press to skip to previous 10th track or press & hold to return to previous folder
- NUM/FILE/DIR song selection : M/N/O/5

⑰ 6/+10

- Radio mode : Press & hold to preset station
- USB/SD mode : Press to skip to next 10th song or press & hold to skip to next folder
- NUM/FILE/DIR song selection : P/Q/R/6

⑱ >>I

- Radio mode : Press for auto seek up or press & hold for manual seek up
- USB/SD mode : Press to skip to next song or press & hold to Fast Forward
- NUM/FILE/DIR song selection : Y/Z/(SPACE)/9

⑲ SD SLOT

KEY FUNCTION

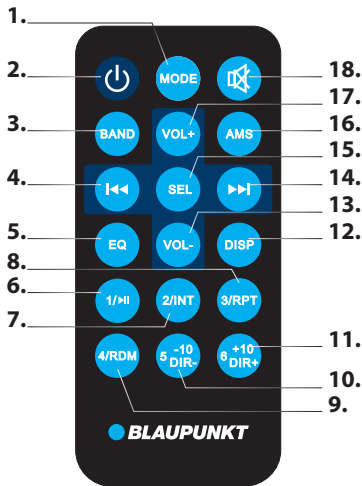

1. Select mode of media
2. Power : On / Off
3. Select stations band
4. Return to previous / fast rewind
5. Select equalizer
6. Pause / play
7. Introduction / song preview (USB/SD)
8. Repeat song
9. Random / shuffle play
10. Return to 10th song / previous folder
11. Skip to 10th song / next folder
12. Press & hold to adjust clock setting
13. Volume down
14. Skip to next / fast forward
15. Select Treble/Bass/Fader/Balance
16. Press & hold to search stations
17. Volume up
18. Mute

FEATURE

Display

- Blue display key with LED backlight
- Fixed Panel

Audio

- 4 x 40W Built-in amplifier
- RCA Rear Preout
- Auto Equalizer

Tuner

- 18 FM Preset Station
- Local Seek Tuning

Media Playback

- MP3/WMA Playback
- USB 2.0/SDHC/CD Playback
- SDHC (Support up to 32GB)
- Front Aux input
- Repeat (Disc/Title)
- Folder search and ID3-tag Display

Accessories

- Remote control

OPERATION

RADIO

- FM
- Presets : 18 FM
- Local seek tuning
- Frequency range : FM/87.5MHZ-108.0MHZ
- Usable sensitivity : FM/15 DB
- Usable sensitivity : 35dB
- Signal-to-noise ratio : 25dB

CD/USB/SDHC

This device support CDs (CDDA) and CD-R/RWs with audio, MP3 or WMA files as well as MP3 or WMA files on USB and SDHC.

Device will automatically play files when CD/USB/SDHC is inserted.

Press **12** to switch between media.

Note : Use only CDs with Compact-Disc logo.

Blaupunkt cannot guarantee the flawless function of copy-protected CDs and all blanks, USB and SDHC available in the market.

CD player

- MP3/WMA
- 2 Channels
- Folder search & ID3-tag

USB

- USB 2.0
- Maximum current supply :1A
- File system : FAT12,FAT16,FAT32
- MP3/WMA decoding format : MP3/MP2/WMA
- Folder search & ID3-tag

SDHC

- Support up to 32GB SDHC
- File system : FAT12,FAT16,FAT32
- MP3/WMA decoding format : MP3/MP2/WMA
- Folder search & ID3-tag

Note : Ensure all media stop playing before removing CD/USB/SDHC

GENERAL

Voltage Supply

Operating voltage : 10.5 - 14.4V

Current Consumption

In operation : <10A

10sec. after switch Off : <3.5mA

Amplifier

Output power : 4 x 24W at 14.4V at 4 ohms

Max output power : 4 x 40W

Tuner

Wavebands in Europe/Asia/Thailand

FM : 87.5 - 108MHz

CD

Frequency range : 20 - 20kHz

Pre-amp out

4 Channels : 4V

Input sensitivity

Front AUX-IN : 300mV/10 ohms

Dimension & weight

WxHxD : 178 x 50 x 160mm

Weight : approx. 1.26kg

INSTALLATION INSTRUCTION

SAFETY

- Assign a mounting location that will not obstruct driver in any circumstances. Or cause injuries to drivers and passengers in case emergency brake or accidents.
- Ensure all wires are connected properly, and that the unit is functioning well before fitting the unit into the mount.
- Any unauthorized installation and modification may cause malfunction to the unit. Always use the parts that are included with the units only.

CAUTION

- Disconnect the negative terminal of the battery (Refer to vehicle manufacturer's safety instructions). Be wary to not damage vehicle components when drilling holes.
- Make sure you do not damage vehicle components when drilling any holes.
- The cross sections of the positive and negative cables must not be less than 1.5 mm².
- Do not connect the vehicle's plug connectors to the radio!
- Your vehicle may differ from the description provided here. Blaupunkt is not liable in case any damage caused by incorrect installation or connection.
- Please contact Blaupunkt dealers or vehicle's manufacturer if information provided here does not fit your specific installation requirement.

When installing amplifier, first connect the device ground connections before connecting the plugs for the line-out jacks.

Ground connection of external devices may not be connected to ground of car sound system (housing).

Supplied mounting hardware

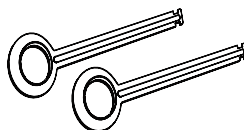
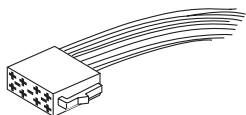
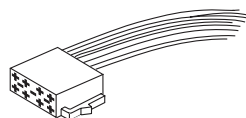
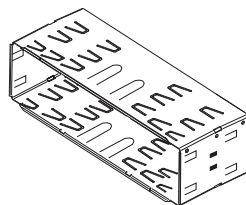

INSTALLATION INSTRUCTION

1.

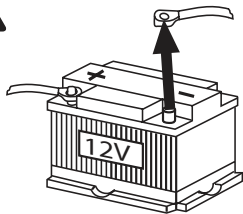

2.

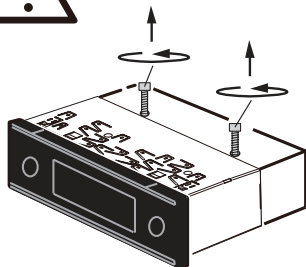

3.

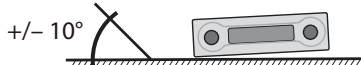
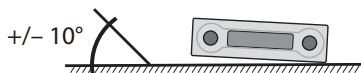
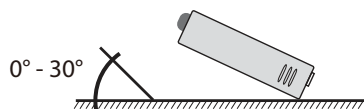

4.

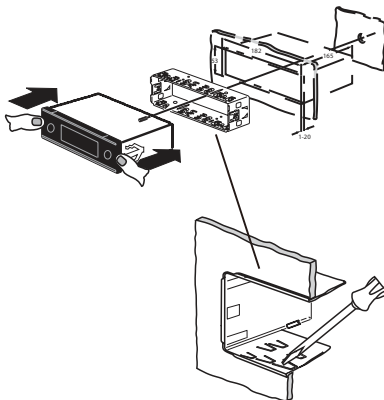

DISMANTLE INSTRUCTION

1.

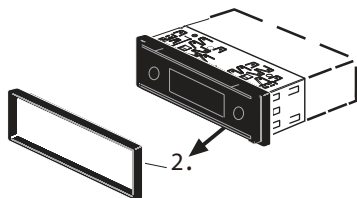

2.

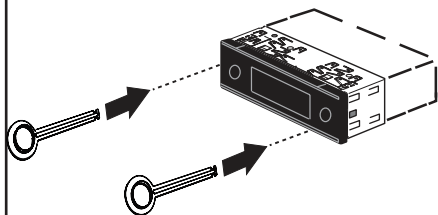

3.

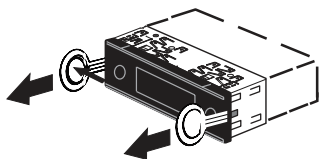

4.

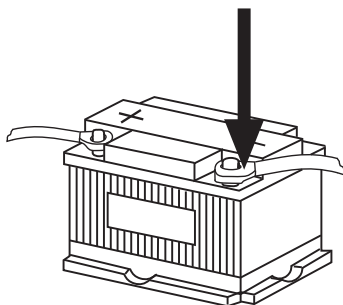

WIRING DIAGRAM

A		B	
1	NC	1	Speaker out RR_
2	Telephone Mute	2	Speaker out RR-
3	NC	3	Speaker out RF+
4	Permanent +12V	4	Speaker out RF-
5	Auto Antenna*	5	Speaker out LF+
6	Illumination	6	Speaker out LF-
7	Kl.15/Ignition	7	Speaker out LR+
8	Ground	8	Speaker out LR-

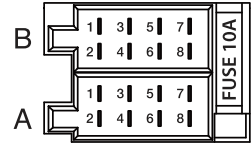

* Switched power supply +12V / max. 150 mA

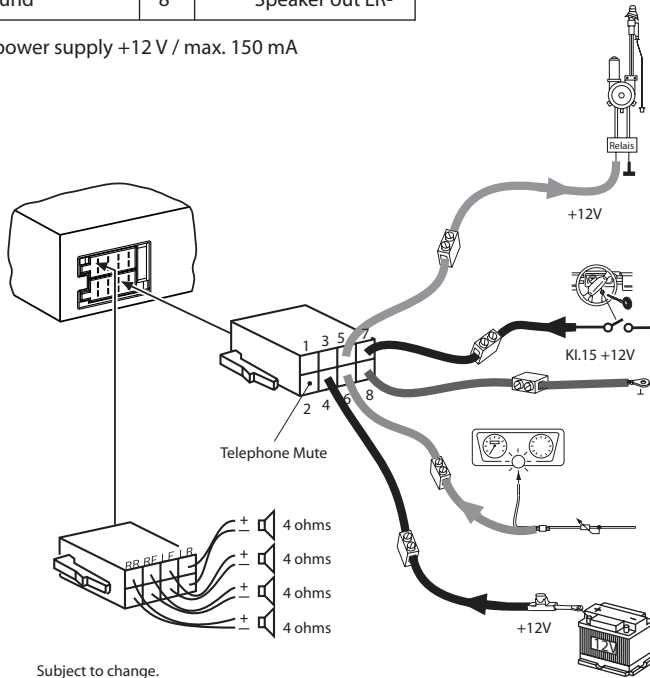

Subject to change.

- This unit is designed for 12V DC negative ground operation system only. Before installing the unit, ensure vehicle is connected to 12V negative ground electrical system
- The negative battery terminal must be disconnected before making connections. This will help to prevent device from being damaged by short-circuit.
- Ensure to connect the colour coded leads correctly according to the diagram. Incorrect connections may cause unit to malfunction and may damage vehicle's electrical system.
- Ensure to connect the speaker (-) leads to the speaker (-) terminal. Do not connect the left and right channel speaker cables to each other or the vehicle.
- Do not block vents or radiator panels. Ensure good ventilation to prevent overheating.

TROUBLESHOOTING

Before going through the checklist, check wiring connection. If any of the problems continue after troubleshooting has been made, consult an authorized dealer.

SYMPTOM	CAUSE	SOLUTION
No power supply	Car ignition turned off	Switch the key position to "ACC" to turn on ignition.
	Broken fuse	Replace the fuse.
Unable to load or eject disc	Presence of disc inside CD slot	Remove the disc from the player before inserting new disc.
	Insert disc in wrong direction	Insert disc with label facing upward.
	Unable to detect dirty disc	Clean disc surface before inserting into player.
	High temperature inside car cabin	Allow car cabin and player to cool off until it return to normal temperature or leave the player off for an hour or so before using again.
No sound output	Low volume	Adjust volume to desire level.
	Wiring connection	Check if wire is connected correctly.
Breaking/skipping sound	Installation angle is more than 30 degree	Adjust installation angle to less than 30 degree.
	Defective disc or dirty disc	Clean the disc or insert new disc.
Operating keys failed to function	Chipset technical error	Press reset button to reset unit.
Unable to connect to radio station and automatic selection is not functioning	Antenna cable connection	Connect antenna cable correctly.
	Weak signals	Select stations manually.

SUPPORTED AUDIO FORMAT

FILE FORMAT	BIT RATE
MP3	32Kbps - 320Kbps
WMA	32Kbps - 320Kbps

