



User manual

Mobile phone SM 02 2019



Enjoy it.

Table of Contents

1. Safety instructions.....	3
2. Technical Specifications	6
3. Getting started	8
3.1 Insert the memory card and SIM card	8
3.2 Removing the memory card and the SIM card.....	8
3.3 Unlock the device.....	9
4. Charging the battery	10
5. Switch the device on and off	10
6. Using the Touch screen.....	10
7. Using the Phone's Buttons.....	12
7.1 Virtual buttons.....	12
7.2 Menu icons	12
8. Manage calls.....	13
8.1 Make calls	13
8.2 Airplane mode	13
8.3 Receive a call	13
8.4 Emergency calls.....	13
9. The Home screen	14
9.1 Notification bar.....	14
9.2 Application Launcher	15
9.3 Customize your home screen	15
10. Connecting to the Internet.....	16
10.1 Configure the Internet:.....	16
10.2 Access Internet via Wi-Fi:	17
11. Messaging	17
12. Multimedia	18

12.1 Camera.....	18
12.2 Photos.....	18
12.3 Music.....	19
13. Contacts.....	20
14. Phone.....	21
15. Search.....	22
16. Google Play Store.....	22
17. More applications.....	22
17.1 Clock.....	22
17.2 E-mail.....	23
17.3 File manager / Files Go.....	23
17.4 Voice recorder.....	23
18. Settings.....	23
18.1 Network & Internet.....	23
18.2 Connected devices.....	25
18.3 Applications and Notifications.....	25
18.4 Battery.....	26
18.5 Display.....	26
18.6 Sound.....	26
18.7 Security and location.....	26
18.8 Users and Accounts.....	27
18.9 System.....	27
19. Handling and maintenance.....	27
20. Recycling your device.....	29
21. Declaration of Compliance.....	29

1. Safety instructions

ATTENTION: Please read this guide carefully. Failure to comply with the safety regulations may be dangerous or illegal, and the manufacturer can not be held liable for any malfunction resulting from improper use.

Safe switch-on

The owner of the device is responsible for the use of the device. Never switch the device on in areas where wireless devices are prohibited or radio interference may be dangerous.

Road safety

Observe the local laws and regulations regarding smartphone usage while driving. If you make a phone call while driving, observe the following rules: Focus on driving to become aware of traffic conditions; If the device has a hands-free function, use handsfree. If the traffic situation requires, stop the car before you pick up the phone.

Interference

Wireless devices may be sensitive to interference that affects performance.

Electronic devices

To avoid demagnetisation, do not leave your device for a long time close to electronic devices.

Use in hospitals

Hospitals and other healthcare facilities can use devices that are particularly sensitive to RF signals. Switch off your phone if prohibited signals are instructed to do so, or hospital staff ask for it.

Electrical medical devices

Your phone is a radio transmitter that can interfere with electronic medical devices or implants such as hearing aids, pacemakers, insulin pumps, and so on. We recommend that you keep a distance of at least 15 cm between the implant and the device, never wear your phone in the breast pocket. Follow the instructions of the manufacturer of the medical device. If you have a medical implant and have any other questions about using mobile or wireless devices, ask your doctor.

Use on the airplane

Your device supports flying mode, please use this feature on the airplane. Follow the instructions on the airplane.

Explosion hazards and restricted areas

Turn off the device in explosion hazardous areas. Sparks in such places may lead to an explosion or fire that may result in serious injury or death. Turn off the device at gasoline or gas filling stations, especially near the fuel pumps. Follow the instructions strictly in locations such as fuel tanks, chemical plants, and explosive substances.

Use environment

The device complies with the recommended emission values for radio waves when kept at a minimum distance of 1.5 cm from the ear. When carrying the phone in a case, belt clip or holder, make

sure that it does not contain metal and that the phone is slightly distracted from the body. When using other accessories, it is not possible to operate in accordance with radio frequency guidelines. If you do not use a case and do not hold the phone on your ear, keep it at least 2.5 cm away from your body, especially during data transfer.

Proper use

Please do not attempt to disassemble the device. If the product is defective, contact your distributor.

Battery and other accessories

Only use parts and accessories approved by the manufacturer. Using non-factory accessories and spare parts may result in warranty loss. Please do not charge the device before inserting the battery. Do not short-circuit the battery.

Charge the appliance in a well-ventilated and suitable temperature environment away from flammable and explosive materials. Handle the used battery according to local regulations and do not throw it into household trash.

Water resistance

The appliance is not waterproof. Precipitation, fog, and other liquids can corrode electronic circuits. If moisture has reached the phone, remove the battery and contact the dealer.

Backup

Make a backup of all the data stored on your device.

Connect to another device

Before connecting an external device, read the safety instructions in this manual. Do not connect an incompatible device.

2. Technical Specifications

Basic Features

- Android™ 8.1 Go edition
- 4.95" FWVGA+ display, 480x960 pixel
- 5 MP front camera
- 8 MP back camera
- 1.3 GHz Quad Core processor
- 1 GB RAM + 8 GB ROM memory
- microSD card up to 32 GB
- 2 NanoSIM card slot
- Multimedia functions
- Wi-fi
- Bluetooth
- 2100 mAh battery
- GSM 900 / 1800 MHz
- WCDMA 900 / 2100 MHz

Power Supply Features:

- Input: AC 100-240V~50/60Hz 0.2 A
- Output: DC 5.0V – 1.0 A

Battery:

- 2100 mAh; 3.8 V

SAR value:

- 0.366 W/Kg (Head)
- 0.911 W/Kg (Body)

The mains power socket used must be close to the charger/holder and easily accessible, so that it can be used as an 'on/off' facility.

Phone layout

The following illustration of the phone is for informational purposes only; your device may be different.



3. Getting started

3.1 Insert the memory card and SIM card

When subscribing to a service provider, they provides a SIM card to use the network. Your SIM card has a phone number and various services, but you can store data on it, for example. phone numbers.

Turn off the power and remove the back cover and battery. Insert the SIM card according to the mark on the device. Make sure that the chip contact and the cut edge of the card are aligned in the correct direction. Slide the card into the slot until it stops. The device handles Nano SIM + Nano SIM + Micro SD cards.

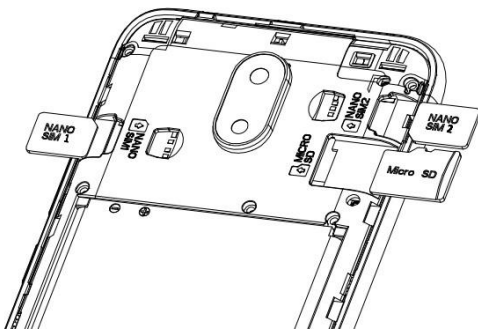

Tip: Insert an SD card to store more media.

Caution: Do not scratch or bend the SIM card. Take care not to get dust or water. Keep away from children.

3.2 Removing the memory card and the SIM card

Note: If the device is turned on, press the Off / Power button for 3 seconds until Turn Off appears on the screen. Select it and then press the OK button. If the device is turned off, remove the memory card and the SIM card. Do not try to remove the memory card while it is booting because the data may be corrupted.

3.3 Unlock the device

To unlock the device, you may need the PIN (not the SIM card PIN), password, or pattern drawing.

Unlock the screen:

1. Press the power key to wake up the phone.
2. Hold and drag the unlock icon to the upward to unlock.

The process of unlocking depends on the pre-configured unlock method.

To set the unlock method:

- On the main menu, touch **Settings > Security & Location**.
- Touch Set up screen lock.
- Choose the type of locking as desired. You can set your screen lock on the basis of Pattern, PIN, Password, Swipe or None.



4. Charging the battery

- Connect one end of the charger to the device.
- Connect the charger to the power outlet.
- Charging will start regardless of whether the device is turned on or not.
- When the phone is turned on, the movement of the battery icon in the upper right corner indicates charging. When the motion stops, the phone is charged.
- When the phone is turned off, the movement of the battery icon on the screen indicates charging. When the motion stops, the phone is charged.
- Disconnect the charger from the power outlet.
- Disconnect the charger from the phone.

5. Switch the device on and off

Press and hold the Power button to turn on the power.

Press and hold the power button and select “Power off” from the Options menu.

6. Using the Touch screen



You can use the touch screen in the following ways:

- **Touch:** Acts on items on the screen, such as application and settings icons, to type letters and symbols using the onscreen keyboard, or to press onscreen buttons.





- **Touch and hold:** Touch and hold an item on the screen until an action occurs.
- **Drag:** Touch and hold an item and move your finger on the screen until you reach the target position.
- **Swipe or slide:** Quickly slide your finger across the surface of the screen, (without dragging an item). For example, slide the screen up or down to scroll a list,
- **Double-tap:** Tap quickly twice on a webpage, map, or other screen to zoom. For example, double-tap a section of a webpage in Browser to zoom that section to fit the width of the screen. You can also double-tap to control the zoom, in Maps, and in other applications.
- **Pinch:** In some applications (Such as Maps, Browser, and Gallery) you can zoom in and out by placing two fingers on the screen at once and pinching them together (to zoom out) or spreading them apart (to zoom in).
- **Rotate the screen:** On most screens, the orientation of the screen changes as you rotate it. You can turn this feature on and off.

7. Using the Phone's Buttons

7.1 Virtual buttons



Button	Description
	Apps: Opens the list of recent applications.
	<u>Home</u> : returns to Home screen. Pressed long opens the Google Assistant™
	<u>Back</u> : returns to the previous screen you were working in

7.2 Menu icons

	Dialer
	Messaging
	Camera
	Browser (Chrome)

8. Manage calls

8.1 Make calls

- Tap the  icon on main menu or the home screen to dial the desired number.
- To dial an international number, touch and hold the 0 key to enter the Plus (+) symbol, and then enter the international country prefix, followed by the phone number.
 - Press the  icon to dial.
 - You can control the volume using the Volume up / down buttons on the side of the unit.
 - Dialer can also open **Call log** and **Contacts**.
- While during a call, touch the  icon to end a call.



8.2 Airplane mode

Some locations like airplanes may require you to turn off your mobile, Wi-Fi, and Bluetooth wireless connections.

- Press and hold the **Power** button.
- Touch the **Airplane mode**.

8.3 Receive a call

In an incoming call, you can choose from the following options:

- Drag the  icon to up to receive the call.
- Drag the  icon to down to reject the call.

8.4 Emergency calls

You can also make emergency calls without a SIM card. For more information, contact your network service provider.

9. The Home screen

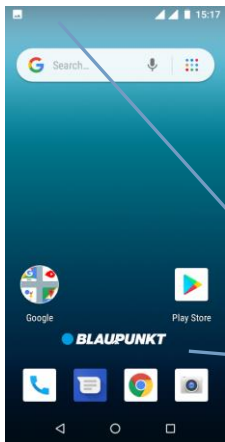

When you sign in, the home screen opens.

The Home screen is your starting point to access all the features on your phone. Touch the main menu icon at the bottom of the screen to view all installed applications.

The status bar shows the time, signal

Touch and hold an empty spot to change wallpaper.

9.1 Notification bar

The notification bar shows your device status and notifications. Notification icons indicate new messages and events. When a new notification arrives, its icon appears in the Notification Bar.

Notification Icons

Status Icons



To see more information about notifications, open the notification panel by swiping your finger over the top of the screen.

Close the notification bar:

Drag the bottom of the notification panel to the top of the screen or simply press the back button. The notification panel will also close when responding to a notification.

9.2 Application Launcher

Drag up the Main Menu arrow at the bottom of the screen to view all installed apps. From here, you can access all installed apps and widgets.

Touch the app to start.

Add an app to the Home screen:

To add an application shortcut to the desktop screen, press and hold it until it vibrates and enters Home screen. Place it and release your finger.

Slide the Launcher up or down to bring more icons into view.

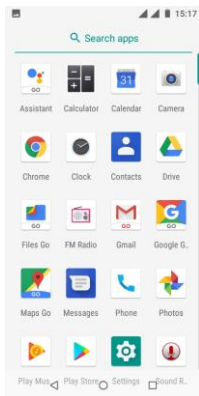

9.3 Customize your home screen

You can add apps, widgets, other links to your Home screens and change the wallpaper.

Set up a wallpaper:

You can add a wallpaper from the Gallery, which includes live wallpapers and pre-installed wallpapers.

Tap on the Home screen anywhere, on an empty surface. From the list that appears, select Wallpapers. Choose an image from the viewer or choose My Photos from other sources in My Photos. Select the photo you

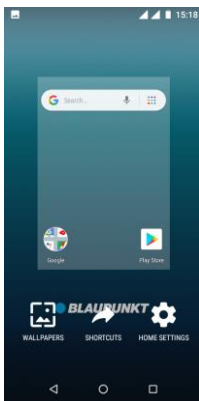

want to set up and confirm it by pressing the Wallpaper Setup at the top of the screen. You can set the selected image to the background of the Home screen, the Background screen of the Lock screen, or both.

Creating folders:

Easily group your apps on the Home screen by creating folders. Besides grouping, you can save space in folders by sorting.

Press the application icon and hold it to move the application. Drag to the icon you want to sort into a folder. This creates a folder to add additional apps.

To rename the folder, click the folder and then type the name on the popup screen keyboard.

10. Connecting to the Internet

Your device has pre-installed browsers to access websites through your mobile device. Open your browser and enter the URL of the page you want to access in the address bar. You must have a subscription to access the web pages, and you must complete the appropriate configuration settings on your device.

10.1 Configure the Internet

Go to Settings > Network & Internet > Data usage > Tap Data Enabled.

By default, your network provider sends the Access Point Name settings via SMS, or it comes automatically with your SIM card. You may need to install these settings. After this, you can choose from the listed access point names. If the access point names are not

listed by default, please contact your network provider for the same.

To add any operator Access point Name, go to **Settings Network & Internet > Mobile network > Access Point Name**.

10.2 Access Internet via Wi-Fi

Go to Settings > Network & Internet > Wi-Fi, then enable Wi-Fi. Next, select the WIFI connection listed under Wi-Fi networks.

11. Messaging

Select Messages in the Main Menu or the Standby screen.

11.1 Send Message

To send a new message, tap the + icon in the right corner of the screen.

Enter the recipient's phone number or select from the Contacts list.

If you have selected the recipients, confirm the arrow icon at the top right of the screen.

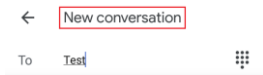

Enter the text of the message and press the send key.

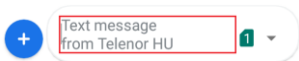

To add an attachment, press the + icon on the left.

When you edit a message, the default message type is SMS. As soon as you add an attachment or reach 10 SMS messages, the phone automatically switches to MMS.

11.2 Input methods

The device contains various input modes. In Editing mode, press and hold [,] to display Input Options and to set the keyboard.

- **Writing Numbers**

Press to display the number keys directly. You can also enter a number with the letters containing the numbers: press and hold, then swipe to the desired character.



- **Writing Symbols**

Press to open the list of symbols. Press the symbol you want to enter.

Press and hold [.] to display the list of symbols, slide your finger to the symbol you want to enter.

12. Multimedia

12.1 Camera

Use the camera to take photos and video clips. To open the camera, press the Camera icon  in the main menu. To take a photo or video, press the recording icon . To set the camera parameters, press the Settings icon in the bottom left corner of the screen.

12.2 Photos

In the Google Photos app, you can view pictures and videos taken with your camera, or those stored on your SD card.

12.3 Music

To play music, on the Applications screen, select Play Music:
In the Music Library, you can switch between the following categories:

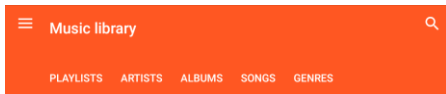

During music playback, you can scroll through the tracks forward, backward, pause playback, or press Options to add to the Playlist. During playback, you can use the following functions:



Repeat



Shuffle Play.

Note: The default music player application is Play Music. Additional playlists can be downloaded from the Play Store.

The Play Music application from the SD card plays the music stored when you save them to My Music. You can play music files stored in your device's internal memory from any directory.

12.4 FM Radio

Connect the headset, then press the FM Radio icon in the main menu. By opening the channel list, the machine automatically searches for and stores available stations.



FM Radio



Channel list



Radio on



Radio off

You can move forward or backward through the channels and add the currently listened channel to Favorites:



13. Contacts

On the Main Menu, select the Contacts icon.

1. To create a new contact, press the New contact icon or enter your Google Account to synchronize your contacts.
2. Select a storage location and enter the contact details.
3. Save the contact.

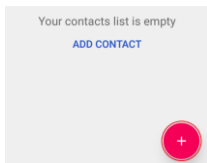

By opening the contact, the following functions are available:



Add a contact to Favorites.



Edit the contact.



Additional options: Delete, Share, Send to Home screen



Dial the number.



Send a message to the phone number.

Additional features available on contacts:

- **Search:** search between contacts.
- **Contacts to display:** You can choose which accounts to be associated with which accounts.
- **Import / Export:** Copy contacts between accounts.
- **Accounts:** Manage Accounts.

14. Phone

From the Main Menu or Standby screen, open the Phone icon to dial or make call settings.



To enter the number to dial, open the dialer.

You can also choose from the following options:

Search for a contact



Dial from Favorites.



View call logs, dialing from call logs.



Open Contacts.

To access the call settings, select the options icon:

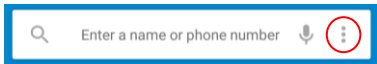

In this menu, you can set the ringtone, display format, quick answers, and Call settings below: Voicemail, Call divert, Call barring, More settings (Call Hold, Caller ID Settings).

15. Search

Your device uses Google search on the Ready screen. Enter the search term in the search queue and press the search button:



16. Google Play Store

Play Store lets you download music, movies, android apps and games. Open the application from the Standby screen or from the Main Menu:



Enter your Google Account information to use this app.

17. More applications

17.1 Clock

You can check the date and time on the clock surface. By pressing the alarm icon, you can set a new alarm, or turn the current alarm on or off. You can set a countdown, stopwatch, or city, night mode in the clock menu.

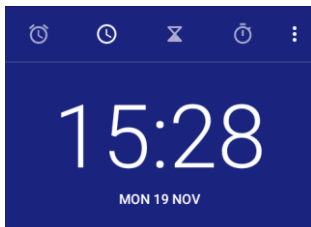

17.2 E-mail

To set up an email account, go to Menu > Gmail, select the type of account you want to set up (Google, Outlook, Yahoo, Exchange, Other).

Enter the email address and password, then follow the on-screen instructions.

17.3 File manager / Files Go

In this menu, you can view, edit, or delete data stored on your device and SD card.

17.4 Voice recorder

Your device supports voice recording. Open Voice Recorder from the Main Menu, then start recording with the Record button. In the Options menu, you can adjust the voice quality and recording mode.

18. Settings

18.1 Network & Internet

Navigate from the Standby screen or from the Main Menu to Settings. Under Network & Internet, you can do the following:

- **Wi-Fi**

Turn on the feature to access Wi-Fi networks. The device automatically displays available networks. Select the network you want to connect to. Enter the password if necessary.

- **Mobile networks**

- In this menu item, you can turn data roaming on or off.

- You can choose from the following network types: Only 2G, 3G only, 3G preferred (2G/3G).
- Edit access points.
- Manually search and choose a network.

- **Data Usage**

In this menu, you can review your data usage, and turn your mobile data on and off. You can set the maximum amount of data that can be marketed through a mobile network (Mobile Data Limit Settings). **Attention!** The service provider can calculate the costs of data traffic in different units.

- **Tethering & portable hotspot**

You can share your device's Internet connection with your PC via USB or by setting a WIFI hotspot.

- **SIM cards**

In this menu item, you can enable / disable the network connection of the inserted SIM cards.

You can select the preferred SIM card for the following features: Mobile Data, Calls, SMS.

- **VPN**

Virtual private networks can be configured in this menu item.

- **Airplane mode**

You can turn Airplane mode on or off in Menu / Settings / Network & Internet. By activating the airplane mode, the device turns off the wireless features (mobile network, Wifi, Bluetooth,

FM radio, GPS), but the multimedia features (Music, Video, Games) can still be used.

18.2 Connected devices

- **Bluetooth**

Your device supports Bluetooth, which allows you to send data wirelessly.

- Turn on the function.
- From the Available Devices list, select the device you want to exchange data with. Before sending data, you need to pair your device with another device.
- To pair, make sure the code on the screen matches the code of the other device.
- If the code matches, confirm.

- **Print**

Adding network printers can print your documents directly from your phone.

- **USB**

You can set how the device works with a computer during a USB connection: Charging the device, Transferring files, Transferring photos (PTP), Using a device as a MIDI device, Built-in CD-ROM

18.3 Applications and Notifications

In this menu you can view apps installed on your device, customize their notifications and permissions.

18.4 Battery

We get information about the battery (current charge, last full upload time, Screen usage since full charge), and power management options (Standby intelligent power saving, Battery saver, Battery percentage, Adaptive brightness, Sleep).

18.5 Display

Device Display and Display Settings: Brightness, Adaptive Brightness, Wallpaper, Sleep, Auto rotate screen, Font Size, Display Size

18.6 Sound

It is possible to set the device's ringtone, volume, and other tones.

18.7 Security and location

We get a general overview of the security status of your device, set different device security and privacy rules.

- **Screen lock**

In this menu, you can set screen lock on your device to prevent unauthorized access.

- **Location**

In this menu, you can set how the device determines your location:

- o GPS, Wifi, bluetooth, mobile network (Very accurate)
- o Wifi, bluetooth, cellular networks (Energy Saving)
- o GPS (On device only)

- **SIM card lock**

You can turn the PIN code on or off and change the SIM card PIN.

18.8 Users and Accounts

You can add a new account (corporate, personal, other) to this device in this menu item. Select the account type from the list and follow the on-screen instructions.

18.9 System

This menu option allows you to perform language settings, adjust gestures, set Date & Time, Backup, Restore Settings, Schedule Power On / Off, and get information about the device.

- **Languages & Input**

Select the language, keyboard, and input you want to use. You can also set up voice control, text capability, personal dictionary, virtual and physical keyboard, spell checking, and pointer speed.

19. Handling and maintenance

- **Battery**

The device has a rechargeable battery. When the power supply is low, charge the battery.

Disconnect the charger from the power outlet and the appliance when not in use. Do not allow the battery to charge for more than a week, as it may reduce the battery life.

Extreme temperatures may also affect the battery. If the ambient temperature exceeds 40 ° C, do not charge the battery.

Do not use a damaged battery or charger.

Do not short-circuit the battery. For example, a metallic object such as a coin, clip or pen may cause a short circuit.

Do not leave the battery too hot (such as in a car in summer) or too cold (such as freezing), as it may reduce its service life. Try to store the battery between 15 ° C and 25 ° C. A too cold or too hot battery may temporarily not work, even if it is fully charged.

Do not throw the battery in a fire. Dispose of the used battery according to local regulations and recycle if possible.

● **Maintain the appliance**

Keep the appliance dry. Precipitation, mist and all other liquids can cause corrosion in the circuit boards. If it is still wet, remove the battery. Do not put it back until the product is completely dry.

Do not store the product in dusty places, as moving parts and electrical accessories may be damaged.

Do not store the device in hot places. High temperatures can shorten the life of the electrical devices, damage the battery and melt the plastic parts.

Do not store the device in a cold place. When the device returns to normal temperature, the inside moisture can damage the electrical circuits.

Open the appliance only as instructed in this manual.

Do not drop, shake the appliance as small parts break.

Do not use strong chemicals or solvents to clean the appliance.

Do not paint the appliance. Paint can clog the moving parts and hinder proper operation.

Use only approved parts, improper parts may damage the unit and may result in warranty loss. If the product does not work properly, consult the service provided on the warranty card.

The manufacturer is not liable for any malfunction resulting from improper use.

20. Recycling your device



The logo on the left indicates that the product should not be disposed of in household waste. Dispose of such devices at a collection point for hazardous waste (electronic waste).

21. Declaration of Compliance

The Blaupunkt SM02 2019 model complies with the essential requirements and relevant provisions of the 2014/53/EU Directive and RoHS Directive 2011/65/EU. The Declaration of Conformity is available on our website.



Designed and Engineered by
Blaupunkt Competence Center Mobile Europe
HTM Mobile Kft.

1118 Budapest, Dayka Gábor utca 3. Hungary

Assembled in P.R.C by

HONGKONG SYMSONIC TECHNOLOGY CO., LIMITED

FIAT B07, 23/F HOVER IND BLDG NO. 26-38 KWAI CHEONG RD NT
HONG KONG

For more information on this product, visit our website at www.htmmobile.hu or www.blaupunkt.com.

Google, Android and Google Play, is a trademark of Google LLC.